

# VX16s

## All-in-One Controller



Specifications

## Change History

Document Version	Release Date	Description
V1.3.1	2024-10-23	Added the description for the maximum resolution supported of HDMI 2.0 connector.
V1.3.0	2024-01-15	<ul style="list-style-type: none"> <li>• Added the description for the input source hot backup function.</li> <li>• Added the description for the Ethernet port backup test.</li> </ul>
V1.2.0	2022-12-02	<ul style="list-style-type: none"> <li>• Updated the product rear panel picture.</li> <li>• Added the OSD function descriptions.</li> </ul>
V1.1.0	2021-11-23	<ul style="list-style-type: none"> <li>• Updated the certifications.</li> <li>• Updated the rear panel.</li> </ul>
V1.0.1	2020-10-22	Updated the certifications.
V1.0.0	2020-06-16	First release

## Introduction

The VX16s is NovaStar's new all-in-one controller that integrates video processing, video control and LED screen configuration into one unit. Together with NovaStar's video control software V-Can, it enables richer image mosaic effects and easier operations.

The VX16s supports a variety of video signals, Ultra HD 4Kx2K@60Hz image processing and sending capabilities, as well as up to 10,400,000 pixels.

Thanks to its powerful image processing and sending capabilities, the VX16s can be widely used in applications such as stage control systems, conferences, events, exhibitions, high-end rental and fine-pitch displays.

## Certifications

CE, FCC, IC, RoHS, CB

**If the product does not have the relevant certifications required by the countries or regions where it is to be sold, please contact NovaStar to confirm or address the problem. Otherwise,**

**the customer shall be responsible for the legal risks caused or NovaStar has the right to claim compensation.**

## Features

- Industry-standard input connectors
  - 2x 3G-SDI
  - 1x HDMI 2.0
  - 4x SL-DVI
- 16 Ethernet output ports load up to 10,400,000 pixels.
- 3x independent layers and 1x OSD
  - 1x 4Kx2K main layer
  - 2x 2Kx1K PIPs (PIP 1 and PIP 2)
  - Adjustable layer priorities
  - 1x OSD
- DVI mosaic
 

Up to 4 DVI inputs can form an independent input source, which is DVI Mosaic.
- Decimal frame rate supported
 

Supported frame rates include 23.98 Hz, 29.97 Hz, 47.95 Hz, 59.94 Hz, 71.93 Hz and 119.88 Hz.
- 3D
 

Supports 3D display effect on the LED screen. The device output capacity will be halved after the 3D function is enabled.
- Personalized image scaling
 

Three scaling options are pixel-to-pixel, full screen and custom scaling.
- Image mosaic
 

Up to 4 devices can be linked to load a super large screen when used together with the video distributor.
- Intuitive device operation and control via V-Can
- Up to 10 presets can be saved for future use.
- EDID management
 

Custom EDID and standard EDID supported
- Device backup design
 

In backup mode, when the signal is lost or the Ethernet port fails on the primary device, the backup device will take over the task seamlessly.
- Supports input source hot backup.
- Ethernet port backup test
 

Test whether the pre-stored images, backup Ethernet ports and devices take effect without plugging and unplugging the Ethernet cables.

## Appearance

### Front Panel

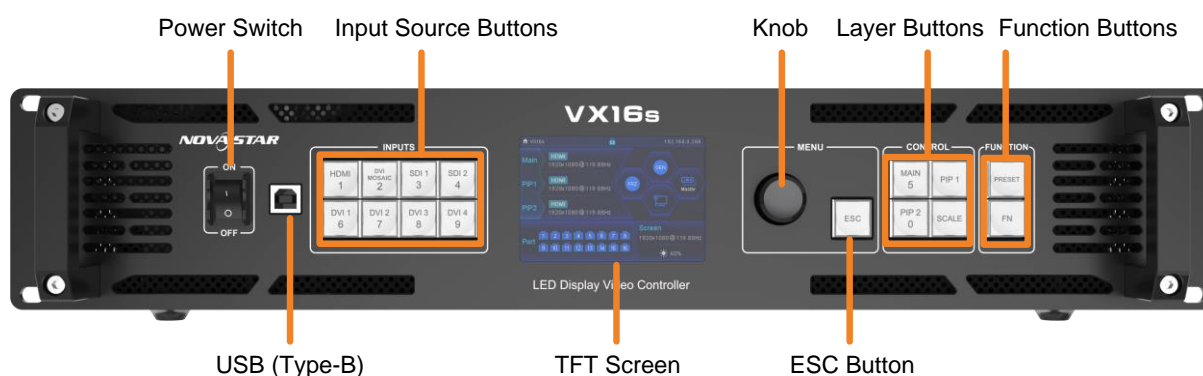

Button	Description
Power switch	Power on or power off the device.
USB (Type-B)	Connect to the control PC for debugging.
Input source buttons	<p>On the layer editing screen, press the button to switch the input source for the layer; otherwise, press the button to enter the resolution settings screen for the input source.</p> <p>Status LEDs:</p> <ul style="list-style-type: none"> <li>• On (orange): The input source is accessed and used by the layer.</li> <li>• Dim (orange): The input source is accessed, but not used by the layer.</li> <li>• Flashing (orange): The input source is not accessed, but used by the layer.</li> <li>• Off: The input source is not accessed and not used by the layer.</li> </ul>
TFT screen	Display the device status, menus, submenus and messages.
Knob	<ul style="list-style-type: none"> <li>• Rotate the knob to select a menu item or adjust the parameter value.</li> <li>• Press the knob to confirm the setting or operation.</li> </ul>
ESC button	Exit the current menu or cancel the operation.
Layer buttons	<p>Press a button to open a layer, and hold down the button to close the layer.</p> <ul style="list-style-type: none"> <li>• MAIN: Press the button to enter the main layer settings screen.</li> <li>• PIP 1: Press the button to enter the settings screen for PIP 1.</li> <li>• PIP 2: Press the button to enter the settings screen for PIP 2.</li> </ul>

	<ul style="list-style-type: none"> <li>• <b>SCALE:</b> Turn on or turn off the full screen scaling function of the bottom layer.</li> </ul>
Function buttons	<ul style="list-style-type: none"> <li>• <b>PRESET:</b> Press the button to enter the preset settings screen.</li> <li>• <b>FN:</b> A shortcut button, which can be customized as a shortcut button for Synchronization (default), Freeze, Black Out, Quick Configuration or Image Color function</li> </ul>

## Rear Panel

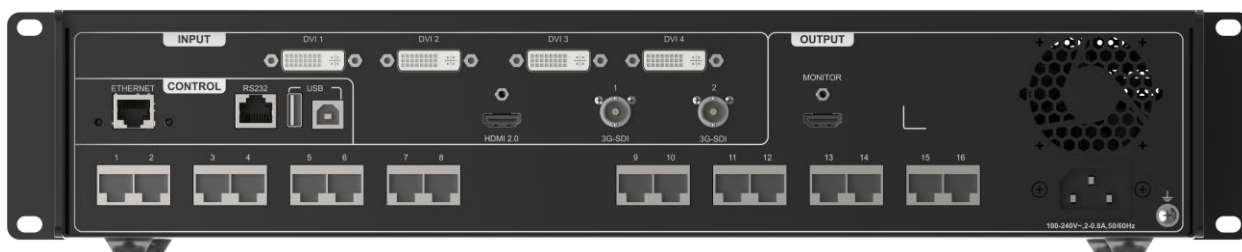

Input		
Connector	Qty	Description
3G-SDI	2	<ul style="list-style-type: none"> <li>• Max. input resolution: Up to 1920×1080@60Hz</li> <li>• Support for interlaced signal input and deinterlacing processing</li> <li>• Does not support input resolution settings.</li> </ul>
DVI	4	<ul style="list-style-type: none"> <li>• Single link DVI connector, with max. input resolution up to 1920×1200@60Hz</li> <li>• Four DVI inputs can form an independent input source, which is DVI Mosaic.</li> <li>• Support for custom resolutions                             <ul style="list-style-type: none"> <li>– Max. width: 3840 pixels</li> <li>– Max. height: 3840 pixels</li> </ul> </li> <li>• HDCP 1.4 compliant</li> <li>• Does not support interlaced signal input.</li> </ul>
HDMI 2.0	1	<ul style="list-style-type: none"> <li>• Max. input resolution: Up to 3840×2160@60Hz</li> <li>• Support for custom resolutions                             <ul style="list-style-type: none"> <li>– Max. width: 3840 pixels</li> <li>– Max. height: 3840 pixels</li> </ul> </li> <li>• Maximum resolution supported: Max. width: 8192 pixels. Max. height: 8192 pixels</li> </ul>

		<ul style="list-style-type: none"> <li>• HDCP 2.2 and EDID 1.4 compliant</li> <li>• Does not support interlaced signal input.</li> </ul>
<b>Output</b>		
<b>Connector</b>	<b>Qty</b>	<b>Description</b>
Ethernet port	16	<ul style="list-style-type: none"> <li>• Gigabit Ethernet output</li> <li>• 16 ports load up to 10,400,000 pixels. <ul style="list-style-type: none"> <li>– Max. width: 16384 pixels</li> <li>– Max. height: 8192 pixels</li> </ul> </li> <li>• A single port loads up to 650,000 pixels.</li> </ul>
MONITOR	1	<ul style="list-style-type: none"> <li>• An HDMI connector for monitoring output</li> <li>• Support for resolution of 1920x1080@60Hz</li> </ul>
<b>Control</b>		
<b>Connector</b>	<b>Qty</b>	<b>Description</b>
ETHERNET	1	<ul style="list-style-type: none"> <li>• Connect to the control PC for communication.</li> <li>• Connect to the network.</li> </ul>
USB	2	<ul style="list-style-type: none"> <li>• USB 2.0 (Type-B): <ul style="list-style-type: none"> <li>– Connect to the PC for debugging.</li> <li>– Input connector to link another device</li> </ul> </li> <li>• USB 2.0 (Type-A): Output connector to link another device</li> </ul>
RS232	1	Connect to the central control device.

**Note:**

HDMI source and DVI Mosaic source can be used by the main layer only.

# Applications

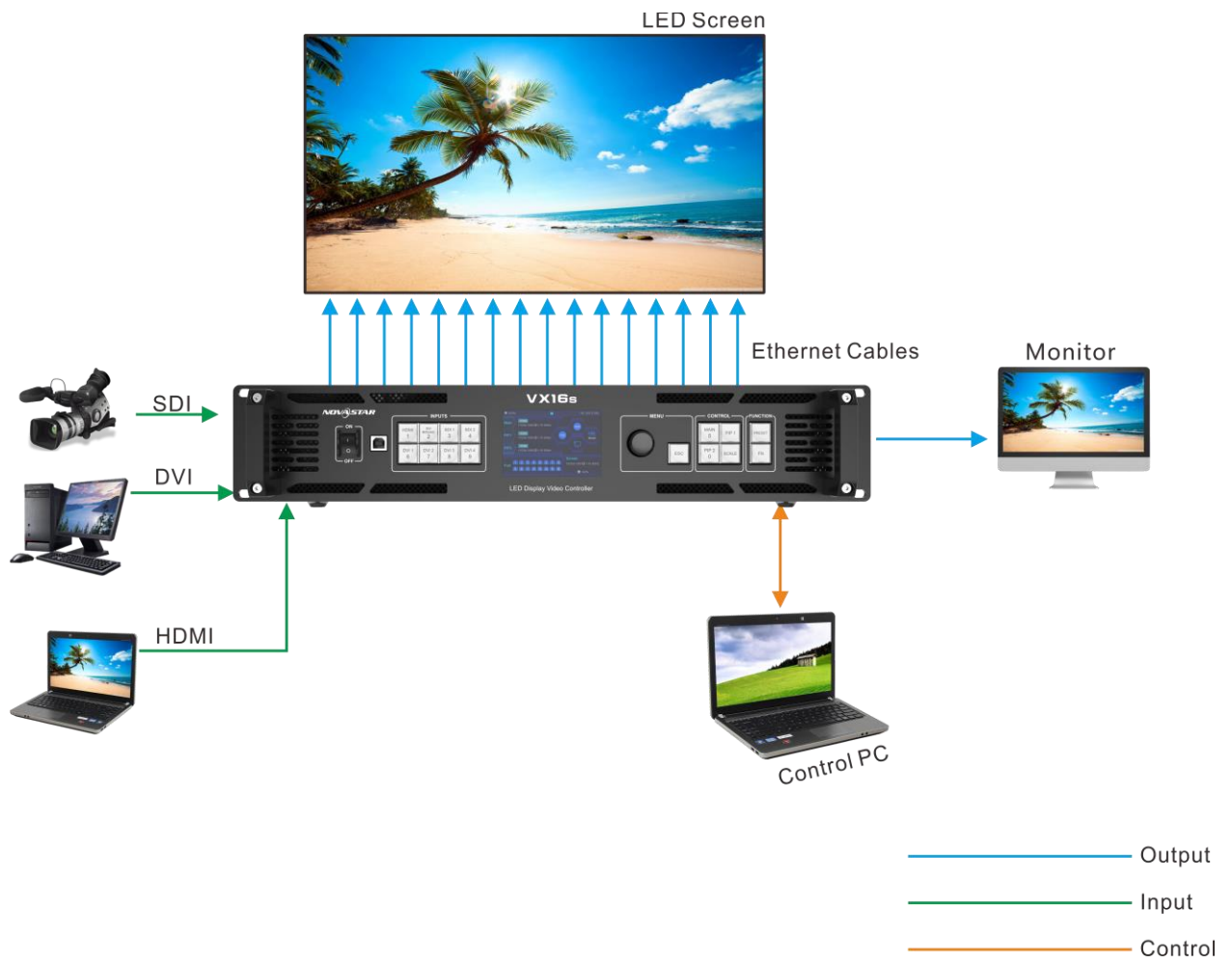

## Dimensions

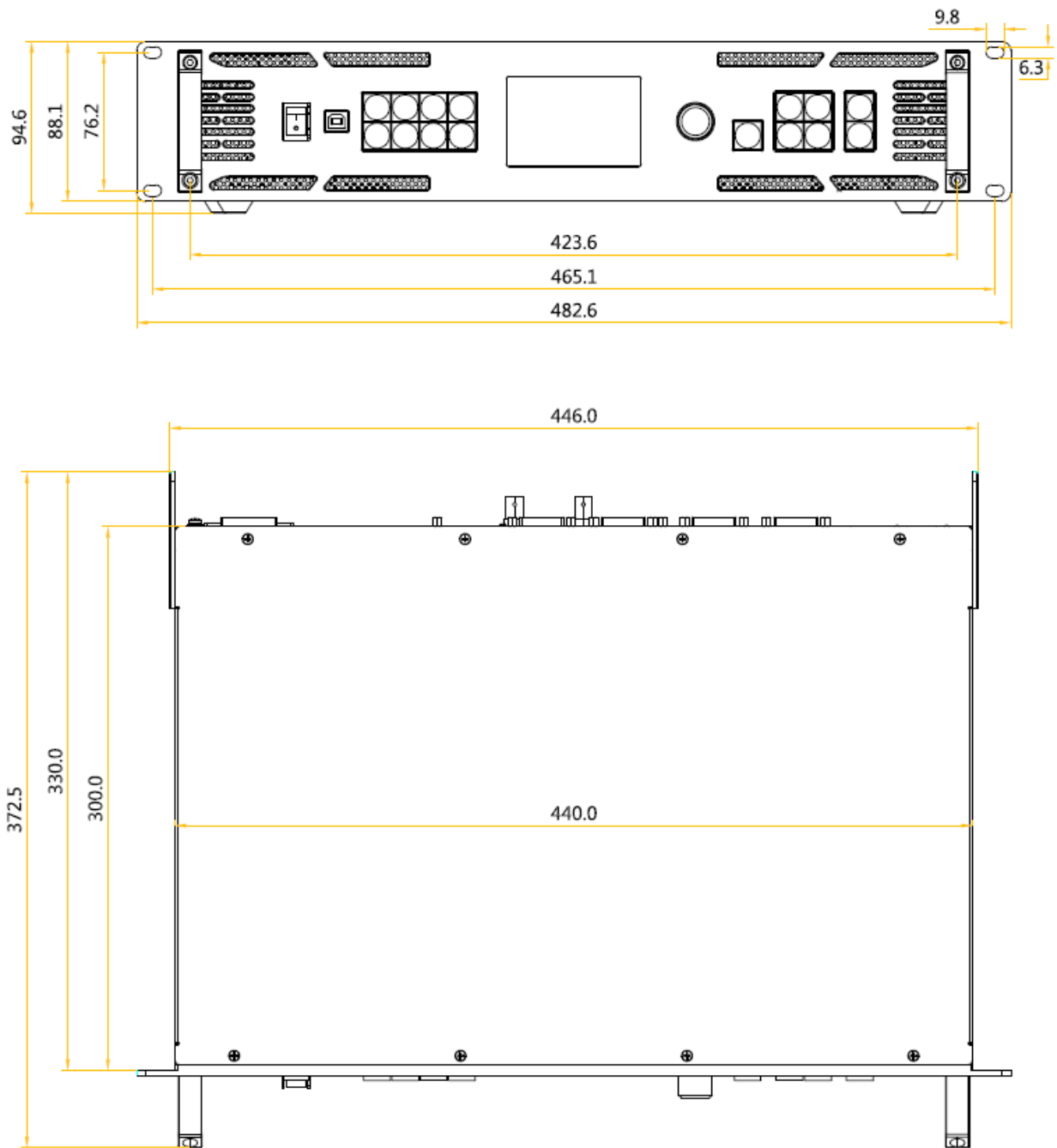

Tolerance:  $\pm 0.3$  Unit: mm

## Specifications

<b>Electrical Specifications</b>	<b>Power connector</b>	100–240V~, 50/60Hz, 2–0.8A
	<b>Power consumption</b>	70 W
<b>Operating Environment</b>	<b>Temperature</b>	0°C to 50°C
	<b>Humidity</b>	20% RH to 85% RH, non-condensing
<b>Storage Environment</b>	<b>Temperature</b>	–20°C to +60°C
	<b>Humidity</b>	10% RH to 85% RH, non-condensing
<b>Physical Specifications</b>	<b>Dimensions</b>	482.6 mm x 372.5 mm x 94.6 mm
	<b>Net weight</b>	6.22 kg
	<b>Gross weight</b>	9.78 kg
<b>Packing Information</b>	<b>Carrying case</b>	530.0 mm x 420.0 mm x 193.0 mm
	<b>Accessories</b>	1x EU power cord 1x US power cord 1x UK power cord 1x Cat 5e Ethernet cable 1x USB cable 1x DVI cable 1x HDMI cable 1x Quick Start Guide 1x Certificate of Approval
	<b>Packing box</b>	550.0 mm x 440.0 mm x 215.0 mm
<b>Noise Level (typical at 25°C/77°F)</b>		45 dB (A)

## Video Source Features

Input Connector	Color Depth		Max. Input Resolution
HDMI 2.0	8-bit	RGB 4:4:4	3840x2160@60Hz
		YCbCr 4:4:4	3840x2160@60Hz
		YCbCr 4:2:2	3840x2160@60Hz
		YCbCr 4:2:0	Not supported
	10-bit/12-bit	RGB 4:4:4	3840x1080@60Hz
		YCbCr 4:4:4	3840x1080@60Hz
		YCbCr 4:2:2	3840x2160@60Hz
		YCbCr 4:2:0	Not supported
SL-DVI	8-bit	RGB 4:4:4	1920x1080@60Hz
3G-SDI	Max. input resolution: 1920x1080@60Hz 3G-SDI signal does not support input resolution settings.		

## Attention

Risk of explosion if the battery is replaced by an incorrect type.

Risque d'explosion si la batterie est remplacée par un type incorrect.

--Disposal of a battery into fire or a hot oven, or mechanically crushing or cutting of battery, that can result in an explosion.

--La mise au feu ou dans un four chaud, ou le broyage ou la découpe mécanique de la batterie peuvent provoquer une explosion.

## Installation Instructions

When the product needs to be installed on the rack, 8 screws at least M5\*8 should be used to fix it. The rack for installation shall bear at least 25KG weight.

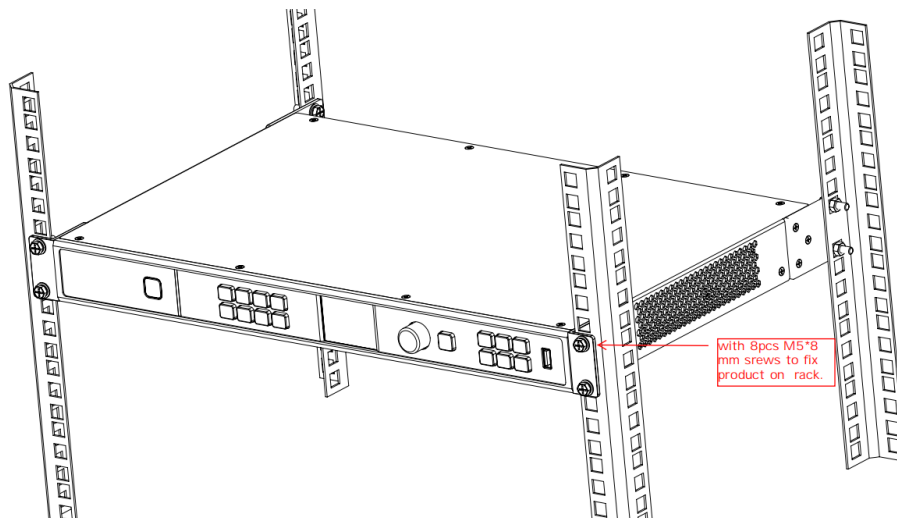

## FCC Caution

Any changes or modifications not expressly approved by the party responsible for compliance could void the user's authority to operate the equipment.

This device complies with part 15 of the FCC Rules. Operation is subject to the following two conditions: (1) This device may not cause harmful interference, and (2) this device must accept any interference received, including interference that may cause undesired operation.

Note: This equipment has been tested and found to comply with the limits for a Class A digital device, pursuant to part 15 of the FCC Rules. These limits are designed to provide reasonable protection against harmful interference when the equipment is operated in a commercial environment. This equipment generates, uses, and can radiate radio frequency energy and, if not



installed and used in accordance with the instruction manual, may cause harmful interference to radio communications. Operation of this equipment in a residential area is likely to cause harmful interference in which case the user will be required to correct the interference at his own expense.

**TECNOGROUP**  
LED TECHNOLOGY EXPERTS

**Tel:** +56 9 5449 1032  
**Email:** [contacto@tecnogroup.cl](mailto:contacto@tecnogroup.cl)

**Casa Matriz**  
Padre Hurtado Central 580  
Las Condes, Santiago de Chile

[www.tecnogroup.cl](http://www.tecnogroup.cl)

 [@tecnogroup.cl](https://www.instagram.com/tecnogroup.cl)  [#tecnogroup.cl](https://www.facebook.com/tecnogroup.cl)  [Tecnogroup Chile](https://www.linkedin.com/company/tecnogroup)

**Tel:** 833 533 4255  
**Email:** [info@tecnogroup.us](mailto:info@tecnogroup.us)

**Showroom Miami**  
759 NW. 24th ST.  
Miami, FL 33127

[www.tecnogroup.us](http://www.tecnogroup.us)

 [@tecnogroup.us](https://www.instagram.com/tecnogroup.us)  [#tecnogroup.us](https://www.facebook.com/tecnogroup.us)  [Tecnogroup USA](https://www.linkedin.com/company/tecnogroup)